

Principles of Adverse Possession

Session 7

76th Surveyor's Institute

Wed 22 Jan 2025

Jerry Mahun, PLS

Retired, retired, retired...

jerry.mahun@gmail.com

715-896-3178

jerrymahun.com



Pop Quiz!!!

1. T or F Based on his/her quasi-judicial capacity, a surveyor is able to render a boundary decision where adverse possession is involved.
2. T or F There must be intent to possess for an adverse claim to ripen.
3. T or F A court decision in a successful adverse possession case will result in new property descriptions.
4. In Wisconsin, the required time for adverse possession is: _____ .
5. T or F The same party must initiate and maintain the possession through the entire required period.
6. T or F Publicly owned land cannot be adversely possessed.
7. Possession based on a written document is called _____ possession.
8. A seemingly good deed which contains a description defect is said to have _____ of title.





I. Some Legal Background

A. Title, Ownership, Possession

B. Written Transfer of Rights

I. Some Legal Background

A. Title, Ownership, & Possession

Title, Ownership, Possession - Definitions*

ownership

The bundle of rights allowing one to use, manage, and enjoy property, including the right to convey it to others. • Ownership implies the right to possess a thing, regardless of any actual or constructive control. Ownership rights are general, permanent, and heritable.



*Definitions are from *Black's Law Dictionary* (9th Ed)



I. Some Legal Background

A. Title, Ownership, & Possession

Title, Ownership, Possession - Definitions

possession

1. The fact of having or holding property in one's power; the exercise of dominion over property.
2. The right under which one may exercise control over something to the exclusion of all others; the continuing exercise of a claim to the exclusive use of a material object.
3. Civil law. The detention or use of a physical thing with the intent to hold it as one's own.
4. (usu. pl.) Something that a person owns or controls.



I. Some Legal Background

A. Title, Ownership, & Possession

Title, Ownership, Possession - Definitions

title

1. The union of all elements (as ownership, possession, and custody) constituting the legal right to control and dispose of property; the legal link between a person who owns property and the property. 2. Legal evidence of a person's ownership rights in property; an instrument (such as a deed) that constitutes such evidence <record your title with the county clerk>.

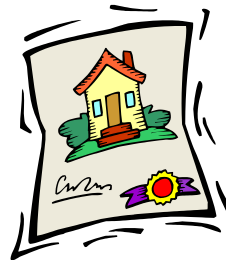
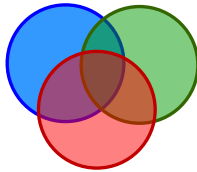

I. Some Legal Background

A. Title, Ownership, & Possession

Title, Ownership, Possession

Example

I buy a truck – receive written *title*.

Who owns the truck?



I. Some Legal Background

A. Title, Ownership, & Possession

Title, Ownership, Possession

Example

I buy a truck – receive written *title*.

Who owns the truck? Me.



I. Some Legal Background

A. Title, Ownership, & Possession

Title, Ownership, Possession

Example

I buy a truck – receive written *title*.

Who owns the truck? Well, me & the Bank.



The Bank has an
interest in my truck.



I. Some Legal Background

A. Title, Ownership, & Possession

Title, Ownership, Possession

Example

I buy a truck – receive written *title*.

Who owns the truck?

Who *possesses* the truck? Me.

I have title, ownership, and possession.



I. Some Legal Background

A. Title, Ownership, & Possession

Title, Ownership, Possession

Example

Someone steals my truck....



Disreputable youth



I. Some Legal Background

A. Title, Ownership, & Possession

Title, Ownership, Possession

Example

Someone steals my truck....

Who has:

Title

Possession

Ownership



I. Some Legal Background

A. Title, Ownership, & Possession

Title, Ownership, Possession

What's a *deed*?

Conveyance document.

Includes the property description.



Does deed guarantee or prove:

Ownership?

Possession?

Title?

No: deed is written *evidence* of title.

In passive title recording system, deed is just one piece of title.



I. Some Legal Background

A. Title, Ownership, & Possession

Title, Ownership, Possession

Relate to land; corners or lines

Deed: defined by written description in deed.

Possession: to where use or control takes place.

Ownership: to where rights extend.

Ideally, all three corners (or lines) would coincide.

But they don't always.



I. Some Legal Background

A. Title, Ownership, & Possession

Title, Ownership, Possession

The three elements may start out vested in a single party

But

Can become separated by individuals' actions.

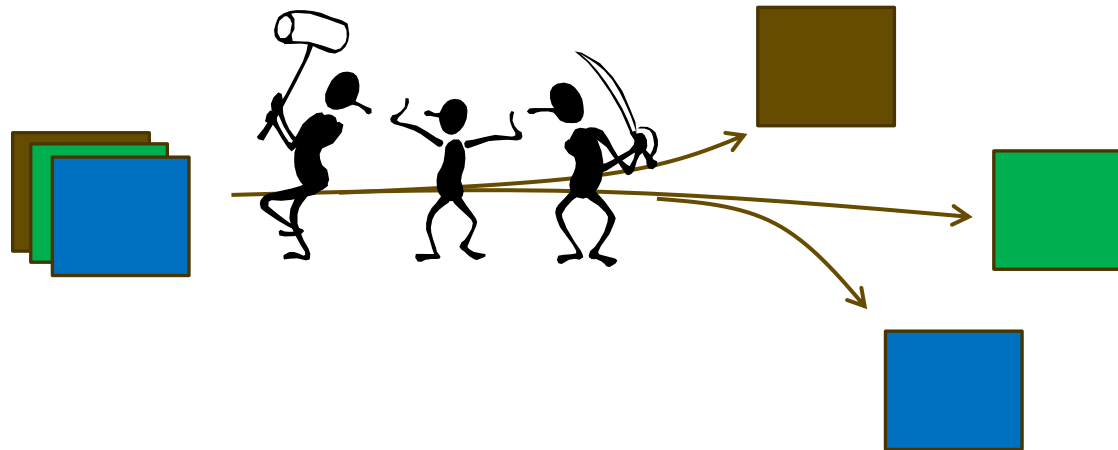

I. Some Legal Background

A. Title, Ownership, & Possession

Title, Ownership, Possession

1985 Sauser and Jaquish purchase lots in new subdiv.

Each lot 250.0' wide on plat.

Mon A & C: *deed* corners.

Jaquish & Sauser: title, ownership, & possession to line AC.

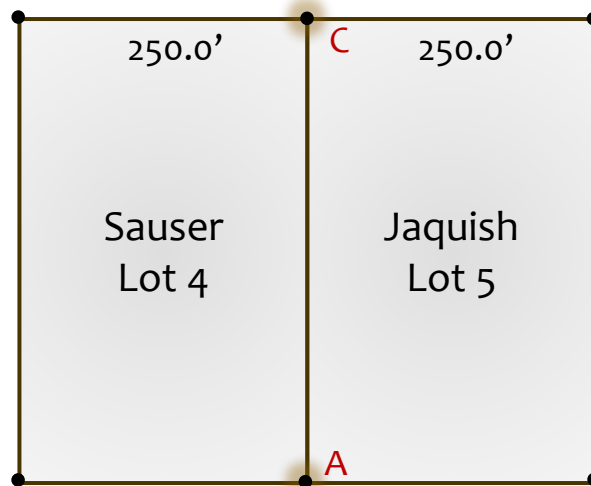

• Original monuments



I. Some Legal Background

A. Title, Ownership, & Possession

Title, Ownership, Possession

1990: Jaquish puts up fence along westerly line.

Finds mon at C but not at A.

Paces 250' from SE cor to locate S end of fence

Plants, mow, etc, with respect to the fence.

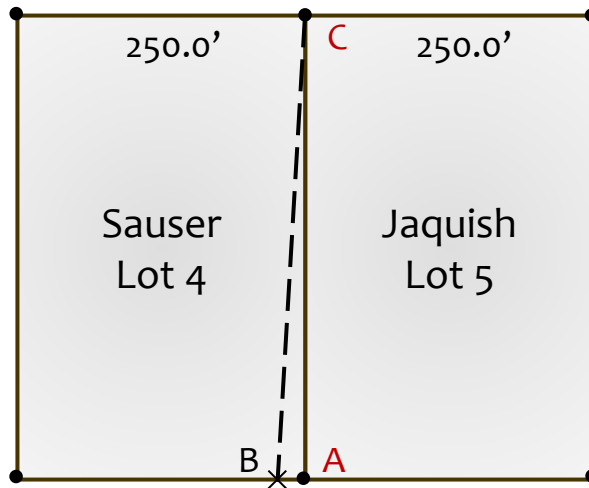

• Original monuments



I. Some Legal Background

A. Title, Ownership, & Possession

Title, Ownership, Possession

Today: Sauser has a survey performed.

Original monument at A is found;

S end of fence is 4.5 ft into Sauser's property.

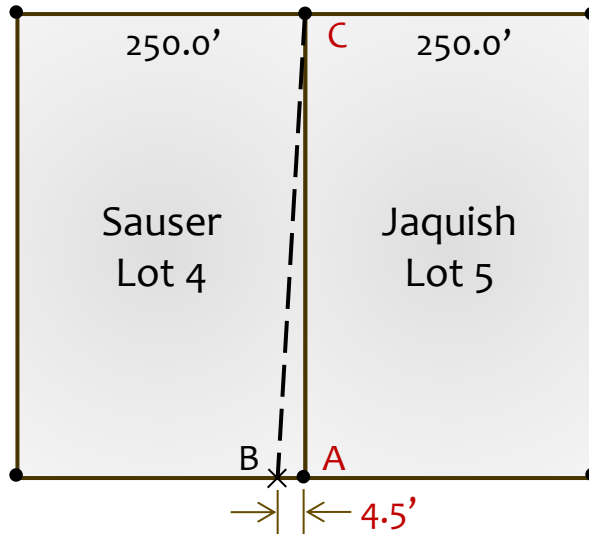

• Original monuments



I. Some Legal Background

A. Title, Ownership, & Possession

Title, Ownership, Possession

ACB: encroachment by Jaquish onto Sauser's property.

Both still have **deeds** to the same line: AC.

Jaquish has **possession** to line BC.

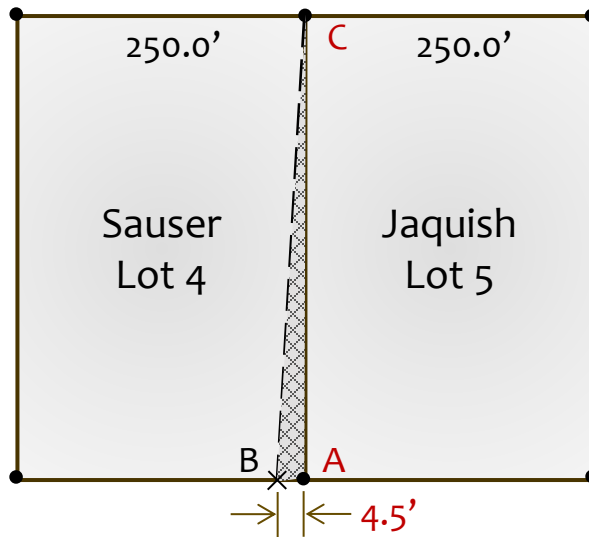

• Original monuments



I. Some Legal Background

A. Title, Ownership, & Possession

Title, Ownership, Possession

Who **owns** what?

It depends. Jaquish can gain ownership to line BC.

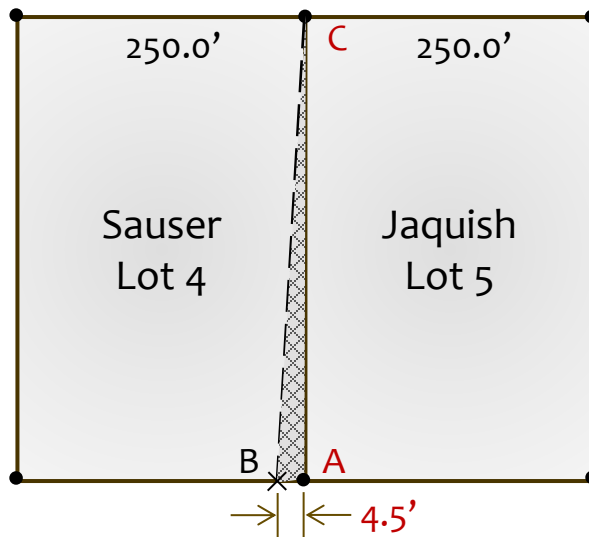

• Original monuments



I. Some Legal Background

A. Title, Ownership, & Possession

Title, Ownership, Possession

If Jaquish obtains ownership of encroachment, he would gain **title** to it even though it is *not included* in his deed's description.

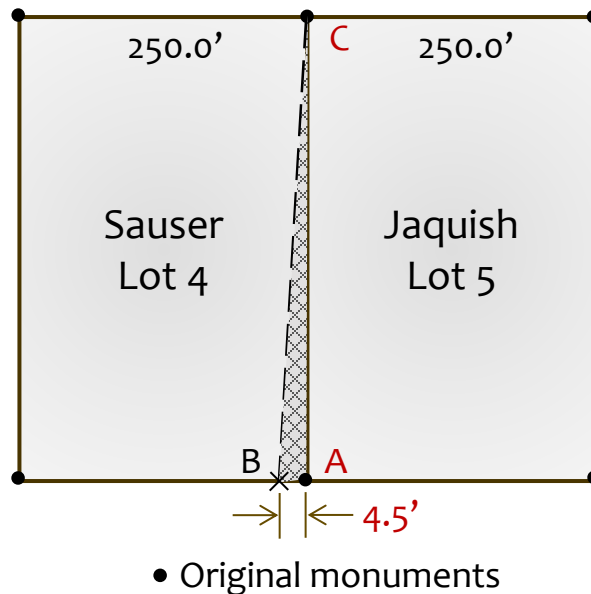

I. Some Legal Background

A. Title, Ownership, & Possession

Title, Ownership, Possession

Particular requirements must be met to avoid “grant theft land.”

These are lumped under the category of *Unwritten Rights*.

Why “unwritten”? That’s next...

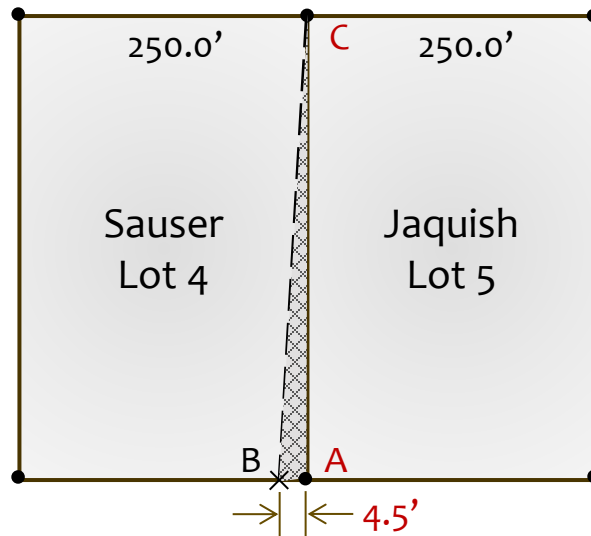

- Original monuments



I. Some Legal Background

B. Written Transfer of Rights

Statute of Frauds (SoF)

English Law 1677

Some contracts must be written to be valid.

Including contracts for property sale.



Why an SoF?

All terms & conditions reduced to writing so original intent is clear to parties involved and anyone having reason to know.

Document stands on its own without having to ask either side what was meant.

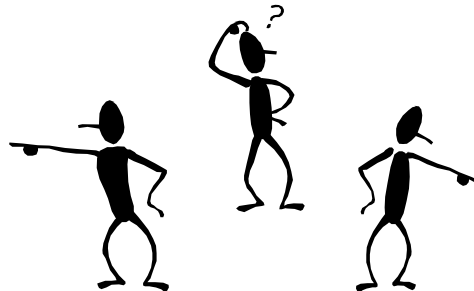

I. Some Legal Background

B. Written Transfer of Rights

Statute of Frauds

A deed is a contract for land transfer.



Description on a deed is the subject matter of the contract.

Defines what the *grantor* conveyed to the *grantee*.

These are the *written intentions of the parties*.

A deed does not have to be recorded to be valid; it only has to be delivered.

Recording a deed is a form of *constructive notice*.

Land can only conveyed by written document.



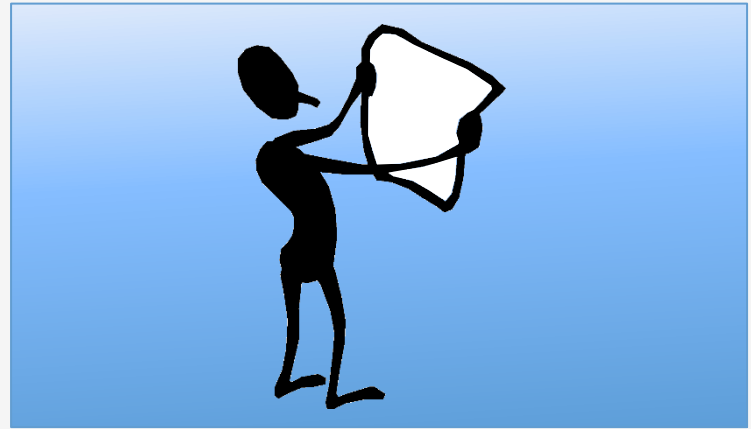

II. Unwritten Rights



- A. General
 - B. Adverse Possession
 - C. Prescription
 - D. The Surveyor and Unwritten Rights
-

II. Unwritten Rights

A. General

1. What's This?

An unwritten right is ownership that is obtained:
without benefit of a written document,
or based on a defective document

Is generally the result of an informal agreement, and/or
action/inaction of affected parties.

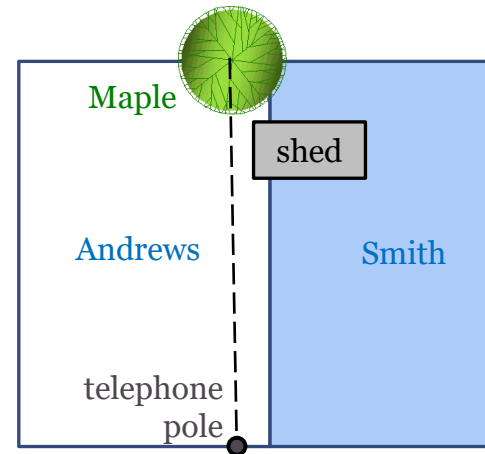

II. Unwritten Rights

A. General

2. Origins

Land transfers pre-date written documents

Traditionally grantor & grantee would:

Walk the exterior,

Point out & touch corners or features,

Witnesses might have been present

Over time successive owners were further removed from original intentions creating

boundary uncertainty

animosity between adjoiners

Hence the creation of the Statute of Frauds.



II. Unwritten Rights

A. General

3. English Common Law

Rooted in feudal principles.

Recognized that two adjacent owners could reach an arrangement on an **uncertain** boundary:

by agreement

by action

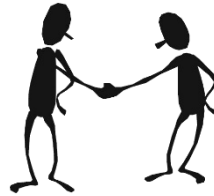

Served to:

stabilize uncertain boundaries,

protect person who acquire interests in good faith from another



II. Unwritten Rights

A. General

3. English Common Law

Landowner was expected to protect, defend, and preserve his ownership rights.



Someone else who possessed and defended the land could gain ownership if he acted more like the owner than the titleholder.

Common law favored the party who keep land productive by using it.



II. Unwritten Rights

A. General

4. What About the Statute of Frauds?



Modern court perspective:

“It is a familiar doctrine of law that the title to real estate cannot be transferred by parole. It is equally forbidden by the principles of common law and express provisions of the Statute of Frauds. This doctrine was recognized early in our law. It is equally settled, however, that the owners of adjoining tracts may, by parole agreement, settle a disputed boundary between them. Such an adjustment of the boundary, if followed by corresponding possession, may be binding on the parties to the dispute, **not because it passes title, but because it determines the location where the estate of each is supposed to exist.**”

Skinner v Francisco, 404 Ill 356, 1949

Courts do not view the situation as title *transfer* but instead as title *clarification*.



II. Unwritten Rights

A. General

5. Methods

Unwritten rights may be established by hostile or peaceful relationships between adjoining owners.

Primary Methods:

Adverse possession

Acquiescence

Equitable estoppel

Parol agreement

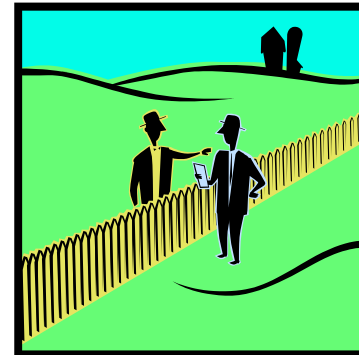

II. Unwritten Rights

A. General

6. Effect

Once established, unwritten rights are binding on the parties to the situation *and* subsequent owners.



II. Unwritten Rights

B. Adverse Possession

1. Concept

People are most familiar (or *think* they are) with adverse possession:

use someone else's land long enough without their permission and you can get ownership of the land.

"Adverse possession is a legal action that enables a party to obtain valid title of another's property by operation of law"

Wilcox v. Estate of Hines, 849 NW 2d 280 - Wis Supreme Court 2014

Adverse possession arises from common law but most states have adverse possession statutes defining requirements.

Ours is Wis State Stat Chp 893



II. Unwritten Rights

B. Adverse Possession

2. General Requirements

Actual	possession/use must physically occur
Open and Notorious	cannot be hidden, title owner has opportunity to see
Exclusive	possessor acts as the owner; does not share use with anyone else
Hostile	against the title owner's interests
Continuous	must be uninterrupted for a specified period of time

"Defendant here claims the use of the road by plaintiff was not "hostile," but our court has made clear that "hostile" does not mean "unfriendly intent" or require "a manifestation of ill will." Rather an act is "hostile" in this context "... when it is inconsistent with the right of the owner and not done in subordination thereto."

Leimert v. McCann, 255 NW 2d 526 - Wis: Supreme Court 1977



II. Unwritten Rights

B. Adverse Possession

3. Tacking

Adverse possession is an ownership claim against a title claim; it's not person against person.

Either title holder or adverse possessor can change without affecting the adverse possession process - tacking

"It has long been the law in Wisconsin that an adverse claimant may "tack" or add his time of possession to that of a prior adverse possession in order to establish a continuous possession for the requisite statutory period."

Perpignani v. Vonasek, 408 NW 2d 1 - Wis: Supreme Court 1987



II. Unwritten Rights

B. Adverse Possession

3. Tacking

Period continues through successive owners.

Assume 20 years is needed to meet an adverse claim.

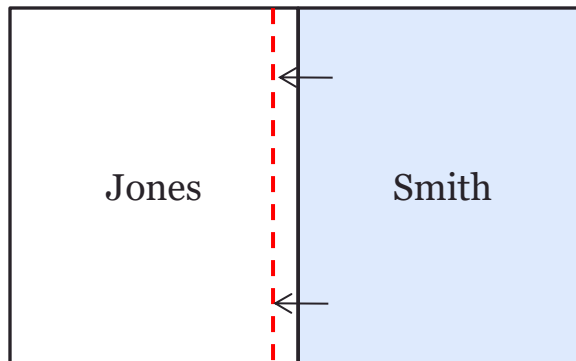

o y 1982 Smith initiates the adverse situation



II. Unwritten Rights

B. Adverse Possession

3. Tacking

Period continues through successive owners.

Assume 20 years is needed to meet an adverse claim.

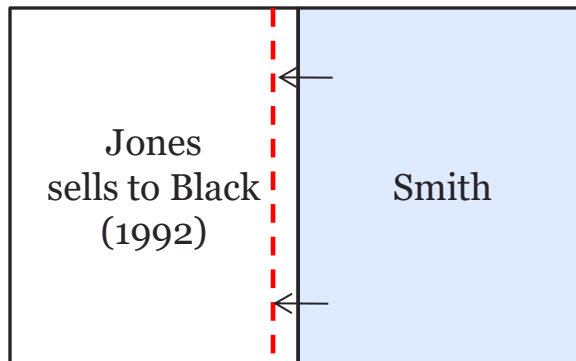

There must be *privity* (legal connection) between successive owners.

0 y 1982 Smith initiates the adverse situation
10 y 1992 Jones sells to Black.



II. Unwritten Rights

B. Adverse Possession

3. Tacking

Period continues through successive owners.

Assume 20 years is needed to meet an adverse claim.

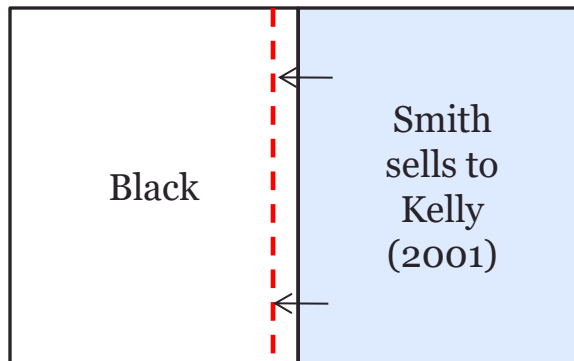

0 y	1982	Smith initiates the adverse situation
10 y	1992	Jones sells to Black.
19 y	2001	Smith sells to Kelly



II. Unwritten Rights

B. Adverse Possession

3. Tacking

Period continues through successive owners.

Assume 20 years is needed to meet an adverse claim.

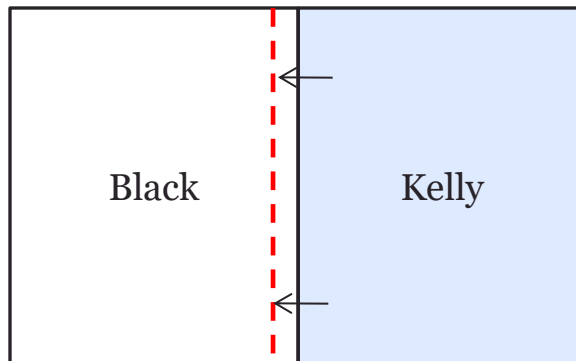

0 y	1982	Smith initiates the adverse situation
10 y	1992	Jones sells to Black.
19 y	2001	Smith sells to Kelly
20 y	2002	Kelly gains successful adverse claim against Black.



II. Unwritten Rights

B. Adverse Possession

4. Type of Possession

Constructive – based on valid written document which contains a *defect*.

This is *color of title*.

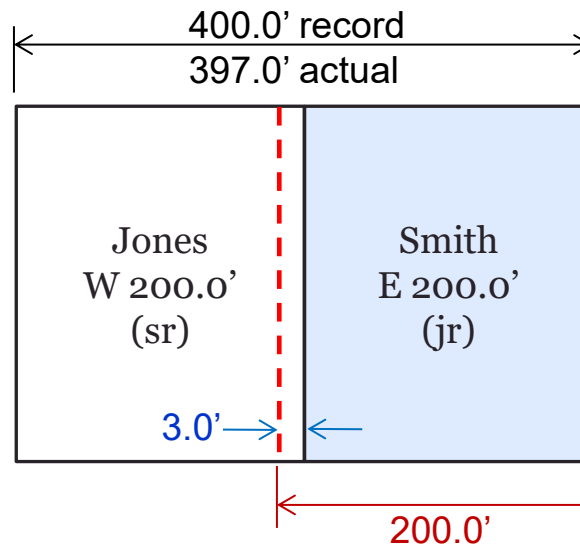

II. Unwritten Rights

B. Adverse Possession

4. Type of Possession

Actual - based on extent of real physical possession.

Generally, is no record basis to substantiate claim.

Example: Black builds a garage that encroaches on Brown's lot.

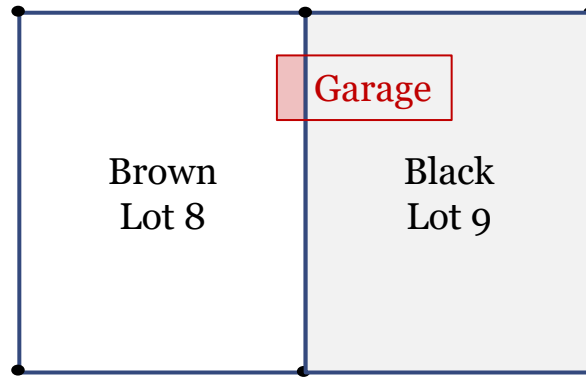

II. Unwritten Rights

B. Adverse Possession

5. Wis Requirements

a. Wis State State Chp 893 Subchp III

SUBCHAPTER III

ACTIONS CONCERNING REAL OR PERSONAL PROPERTY

893.24 Adverse possession; section lines.

893.25 Adverse possession, not founded on written instrument.

893.26 Adverse possession, founded on recorded written instrument.

893.27 Adverse possession; founded on recorded title claim and payment of taxes.

893.28 Prescriptive rights by adverse user.

893.29 No adverse possession against the state or political subdivisions.

893.30 Presumption from legal title.

893.31 Tenant's possession that of landlord.

893.32 Entry upon real estate, when valid as interruption of adverse possession.

893.33 Action concerning real estate.

893.34 Immunity for property owners.

893.35 Action to recover personal property.

893.36 Secured livestock.

893.37 Survey.



II. Unwritten Rights

B. Adverse Possession

5. Wis Requirements

b. Time periods

§893.25 Not founded on written instrument:

Uninterrupted use for 20 Years

Extent is the area is that continually occupied and:

protected by substantial encloser or usually cultivated/improved

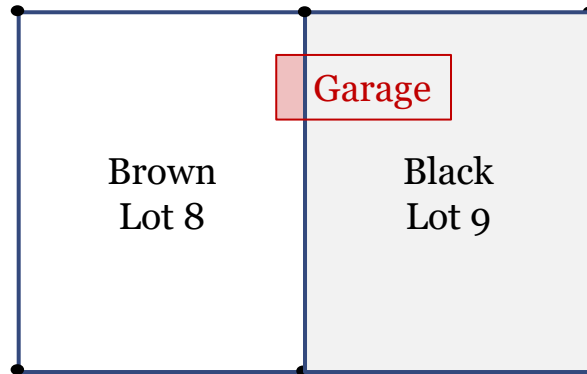

II. Unwritten Rights

B. Adverse Possession

5. Wis Requirements

b. Time periods

§893.26 Founded on written instrument:

Based on good faith title claim (Constructive possession)

Title is recorded within 30 days of initial entry

Uninterrupted use for 10 Years

Broader range of acceptable occupation evidence

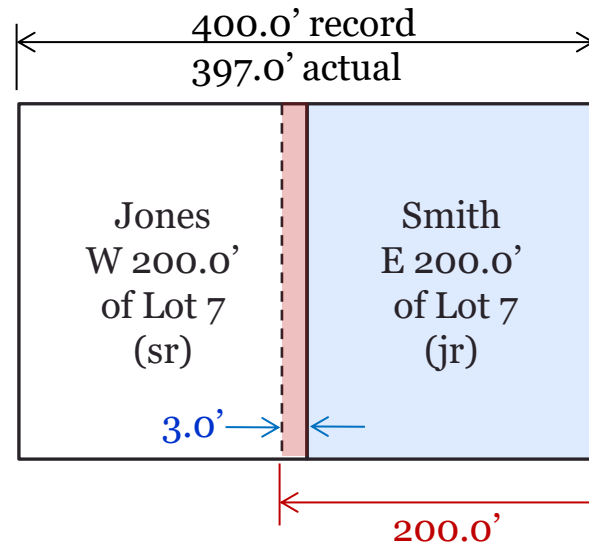

II. Unwritten Rights

B. Adverse Possession

5. Wis Requirements

b. Time periods

§893.27 Founded on written instrument & payment of taxes:

Based on good faith title claim (Constructive possession)

Title is recorded within 30 days of its execution

Uninterrupted use for 7 Years

Broadest range of acceptable occupation evidence

Taxes are paid

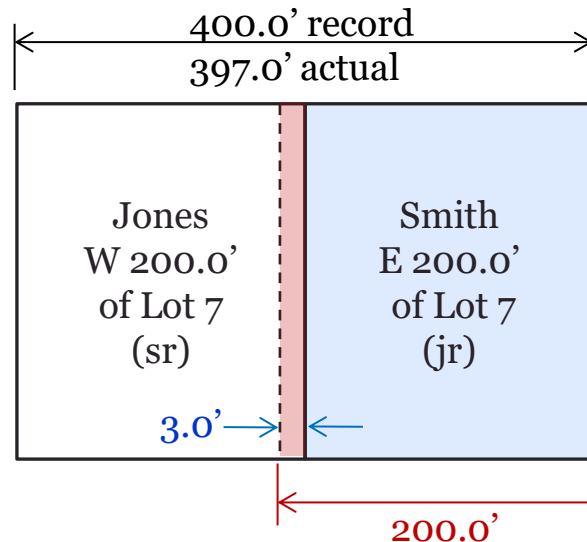

II. Unwritten Rights

B. Adverse Possession

5. Wis Requirements

b. Time periods

Constructive v Actual possession

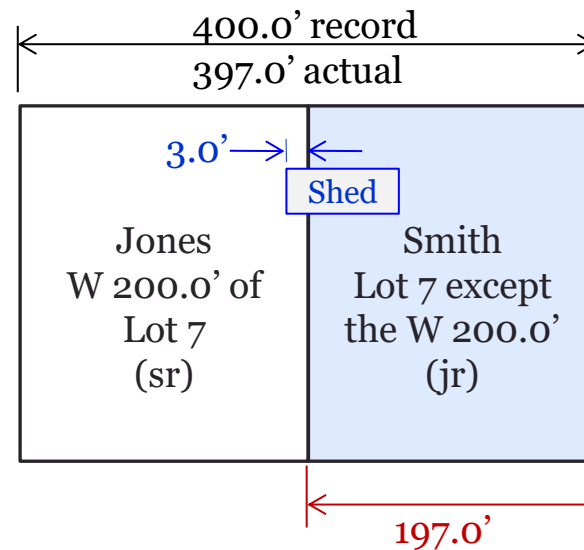
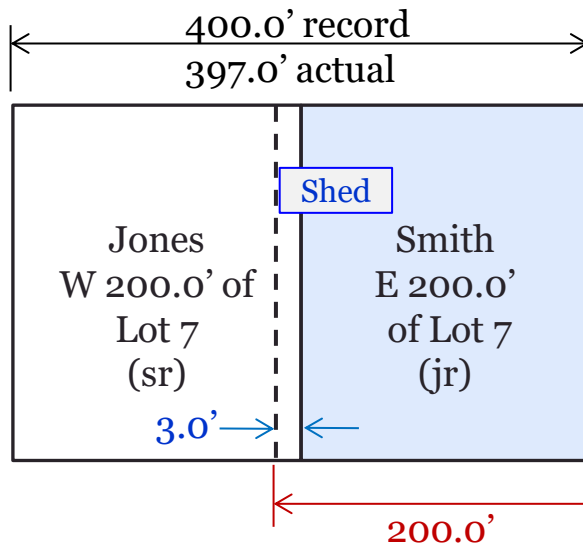

II. Unwritten Rights

B. Adverse Possession

5. Wis Requirements

b. Requirements

Must adverse possession be intentional?

"The harsh result of this rule soon became apparent in many jurisdictions and courts began to hold that land could be acquired by adverse possession, **even though adverse intent was absent**, if the true owner acquiesced in such possession for a period of twenty years."

Buza v. Wojtalewicz, 180 NW 2d 556 - Wis: Supreme Court 1970

What does “usually cultivated or improved” include?

"Improvement doesn't necessarily have to add value to the land.

May just involve changing nature of land so could be visually apparent to owner someone else was using it."

Kruckenbergh v. Krukar, 903 NW 2d 164 - Wis: Court of Appeals 2017



II. Unwritten Rights

B. Adverse Possession

6. Protected Parties

A. Who?

Law protects title holders who are unable to defend their rights. Includes parties with a handicap which prevents their recognizing that rights are in jeopardy.

If handicap is removed, so is protection.

Ex: Minor gaining ownership thru inheritance.

Protected until no longer a minor.



Wis State Stat §893.17

- (a) Person is under age of 18 years.
- (b) Person is insane.
- (c) Person imprisoned ... for a term less than life.



II. Unwritten Rights

B. Adverse Possession

6. Protected Parties

Wis State Stat §893.33(5)

Railroad corporations, Public service corporations, and electric cooperative

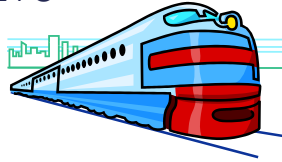

Tolling - the period during which an adverse claim cannot run due to a handicap.

Is an interruption, not cancellation

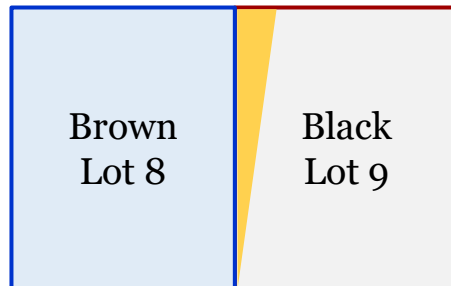

0 yr	2000	Brown initiates possession
7 yr	2007	Black incarcerated
7 yr	2012	Black early-release
20 yr	2025	Claim ripens



II. Unwritten Rights

B. Adverse Possession

6. Protected Parties

In most jurisdictions the public (federal, state, local gov't) cannot be adversely possessed against.

Public land *can* be adversely possessed in Wis:

Wis Stat 893.29 No adverse possession against the state or political subdivisions:

(1) No title to or interest in real property belonging to the state or a city, village, town, county, school district, sewerage commission, sewerage district or any other unit of government within this state may be obtained by adverse possession, prescription or user under s. 893.25, 893.26, 893.27 or 893.28 unless the adverse possession, prescription or user continues uninterrupted for more than 20 years and is based upon a continuously maintained fence line which has been mutually agreed upon by the current landowners.



II. Unwritten Rights

B. Adverse Possession

7. Breaking a claim

Title holder is expected to defend his/her title.

Adverse claimant must meet **all** requirements

but

Title holder needs only **one** to not be met to protect title.

Legal remedies:

Wis Stat 893.305 Affidavit of interruption: adverse possession and prescriptive use

Wis Stat 841 893.32 Entry upon real estate, when valid as interruption of adverse possession.

Wis Stat 841 Declaration of interest in real property

Wis Stat 843 Actions for possession of real property; damages for withholding



II. Unwritten Rights

B. Adverse Possession

8. Solidifying Claim

Adverse claim ripens when all requirements have been met.

"This is because adverse possession of the subject real estate for the limitation period extinguishes the title of the original owner and vests title in the adverse possessor."

Hatch v. Lusignan (1903), 117 Wis. 428, 94 N. W. 332

To protect adverse claim

Wis Stat 893.33(2) - to protect adverse claim

Wis Stat 841 Declaration of interest in real property

Wis Stat 843 Actions for possession of real property; damages for withholding

Note that some laws are the same as ones the title holder can use to break the claim.



II. Unwritten Rights

B. Adverse Possession

9. So, Now What?

What happens to the descriptions of the involved properties?

It depends...

"As in Brockman, we suggest that the parties provide for a permanent description by metes-and-bounds that can be inserted in the judgment to provide a permanent settlement of the controversy ."

Otto v. Cornell, 349 NW 2d 703 - Wis: Court of Appeals 1984

"We further direct the trial court to quiet title to the disputed land accordingly."

Harwick v. Black, 580 NW 2d 354 - Wis: Court of Appeals 1998

If a quiet title action occurs, there will be a record of the modified descriptions.



II. Unwritten Rights

C. Prescription

1. What

Gaining limited rights in a property

Similar to adverse possession so requirements are similar.

Difference: ownership limited only to those rights actually used.

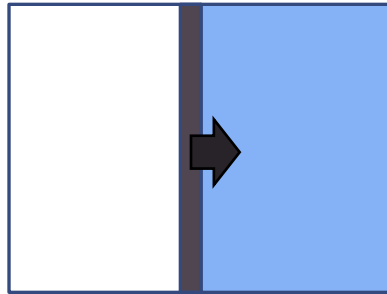

Adverse possession:
All rights pass

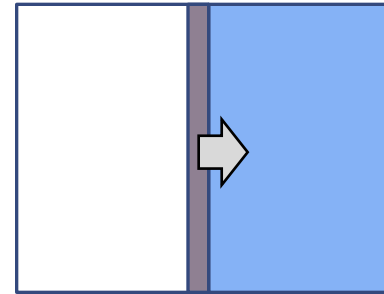

Prescriptive rights:
Limited rights pass



II. Unwritten Rights

C. Prescription

2. Example

Murphy land: road on N, lake on S

For as long as anyone can remember, people walked along west edge of Murphy's land to lake to swim and fish.

The public *may* gain a prescriptive easement across Murphy's land.
Limited to actual use and area over which it occurred.

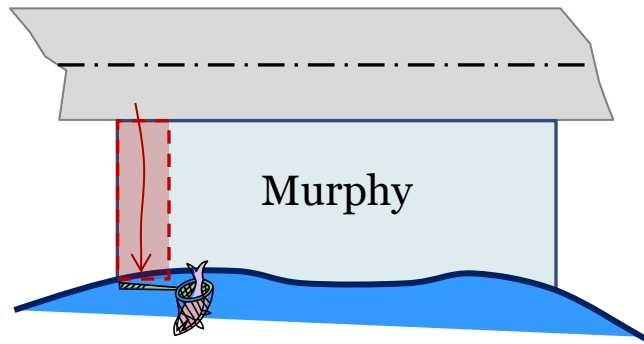

II. Unwritten Rights

C. Prescription

2. Example

Murphy land: road on N, lake on S

For as long as anyone can remember, people walked along west edge of Murphy's land to lake to swim and fish.

The public *may* gain a prescriptive easement across Murphy's land.

In Wis, merely walking across someone's land may not be basis for a prescriptive claim; Wis Stat 893.28(3).

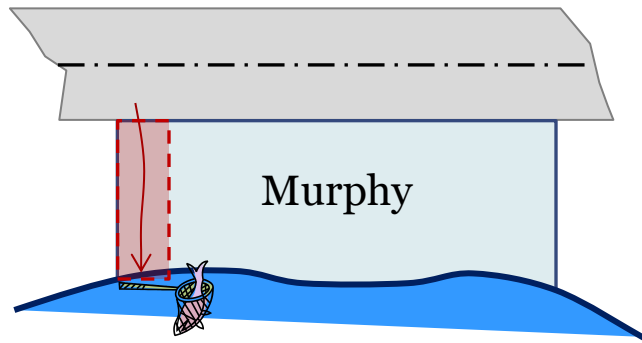

II. Unwritten Rights

C. Prescription

3. Compared to Adverse Possession

Three primary differences

Prescription not based on color of title

20 yrs use;

10 yrs - telcomm, heat/power/elec, co-op

Use is not exclusive

can be many possessors (eg, public)

Only those rights used are gained; underlying fee still with title holder



II. Unwritten Rights

D. The Surveyor and Unwritten Rights

1. Authority

Adverse possession is a *Title* matter, not a *Survey* matter.

What's the difference?

Title matter: Rights associated with ownership;

Survey matter: Concerns corners and boundaries;
can be depicted graphically on a map.

Ownership is determined by court, not surveyor, so why worry about it?

Causes possession and deed line separations.

Which does the physical evidence represent?

Can deed lines be established from possession lines?



II. Unwritten Rights

D. The Surveyor and Unwritten Rights

1. Authority

Surveyor is equipped to:

- interpret written intent
- collect & evaluate evidence
- determine senior/junior relationships
- to re-establish boundaries

Not empowered to determine state of unwritten rights:
whether all elements are present
what ownership status is



II. Unwritten Rights

D. The Surveyor and Unwritten Rights

1. Authority

Wis Admin Code A-E 7.03 Boundary location:

Every property survey shall be made in accordance with the records of the register of deeds as nearly as is practicable. The surveyor shall acquire data necessary to retrace record title boundaries such as deeds, maps, certificates of title and center line and other boundary line locations. ...

By definition, unwritten rights are not in “the records of the register of deeds.”

Unless a quiet title action has occurred.



II. Unwritten Rights

D. The Surveyor and Unwritten Rights

1. Authority

If possession & deed lines don't coincide (taking into acct sr/jr rights), locations must be meas'd & mapped

Information may serve as basis for ripened unwritten claim.

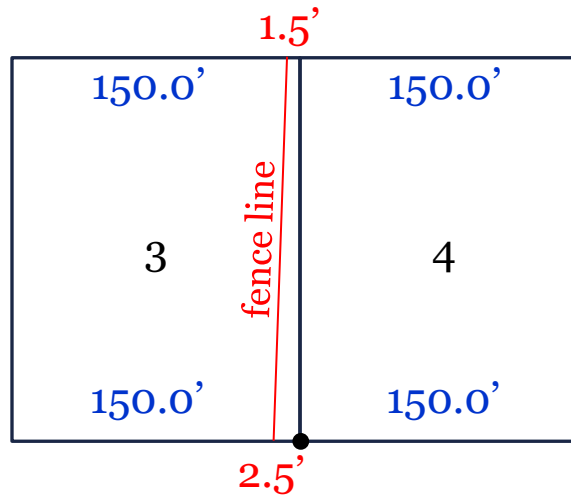

II. Unwritten Rights

D. The Surveyor and Unwritten Rights

1. Authority

While surveyor doesn't determine ownership rights, his/her survey information can be used to help substantiate the necessary elements.

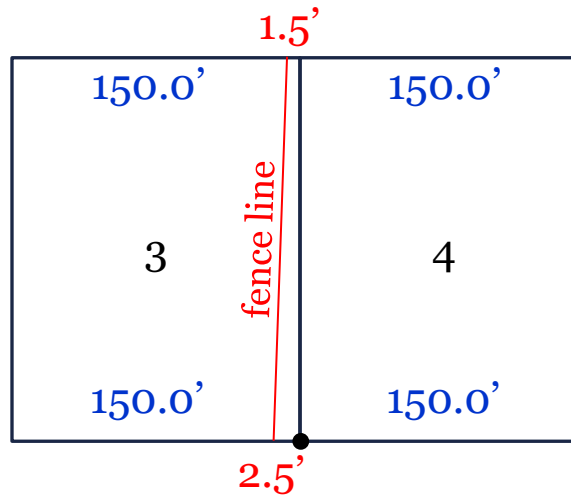

II. Unwritten Rights

D. The Surveyor and Unwritten Rights

2. Unwritten Lines are Local

Lines est'd by unwritten means are local: independent of other property lines.

Lot 3 & 4 deeds will still be based on plat; 150.0' on N & S.
But they may gain ownership to the fence.

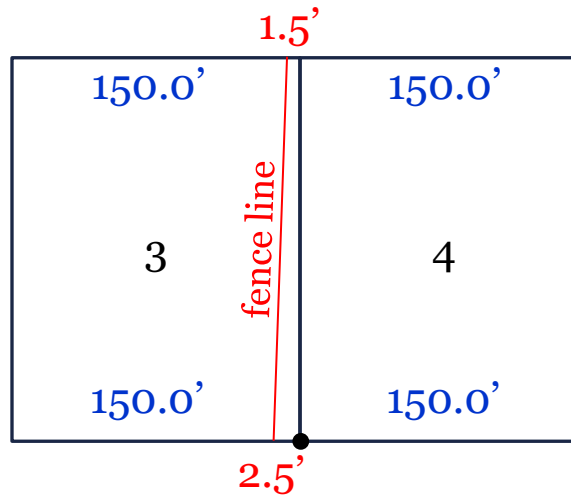

II. Unwritten Rights

D. The Surveyor and Unwritten Rights

2. Unwritten Lines are Local

Lines est'd by unwritten means are local: independent of other property lines.

Lot 3 & 4 deeds will still be based on plat; 150.0' on N & S.
Cannot measure 150 ft E of fence to re-est Larsen NE & SE
or 150 ft W of fence to re-est Thomas NW & SW.

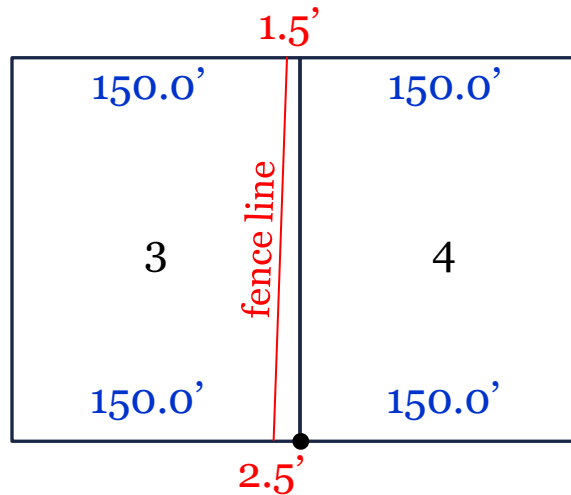

II. Unwritten Rights

D. The Surveyor and Unwritten Rights

2. Unwritten Lines are Local

Lines est'd by unwritten means are local: independent of other property lines.

Similarly, in a row of Lots, can't use fence corners to control proration.

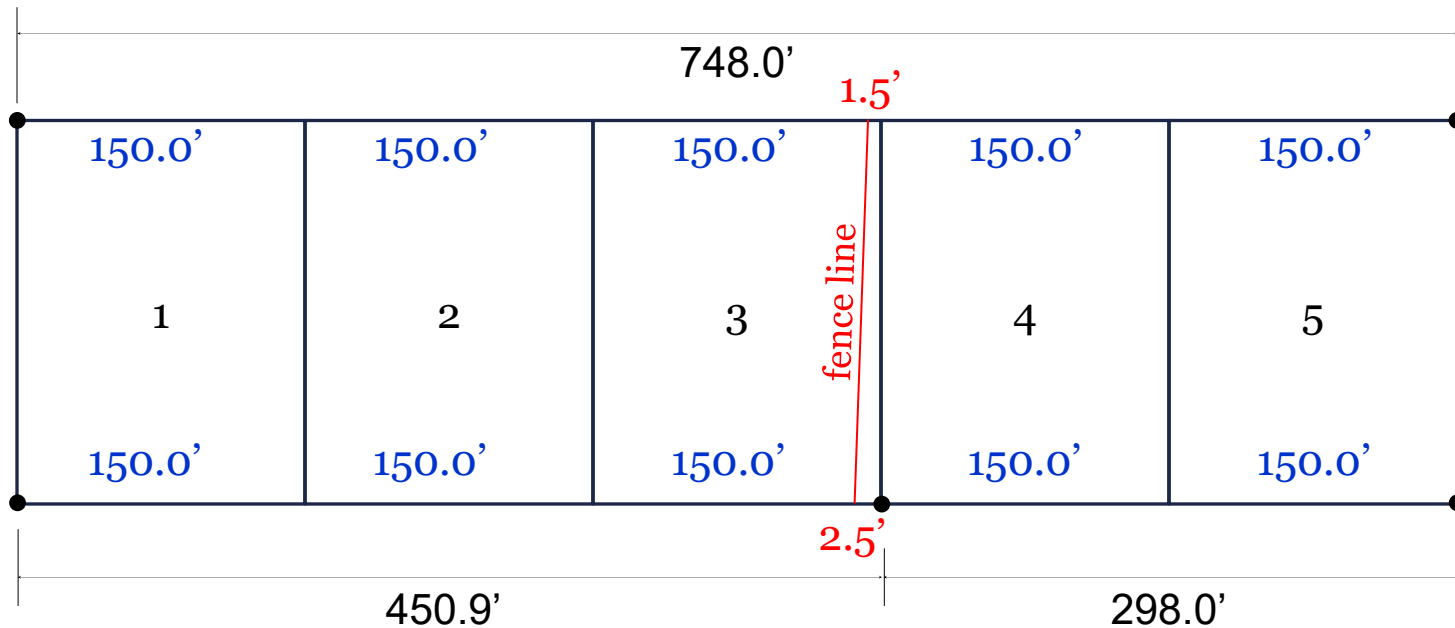

II. Unwritten Rights

D. The Surveyor and Unwritten Rights

2. Unwritten Lines are Local

Lines est'd by unwritten means are local: independent of other property lines.

Similarly, in a row of Lots, can't use fence corners to control proration across.

Must still use original monuments to prorate between.

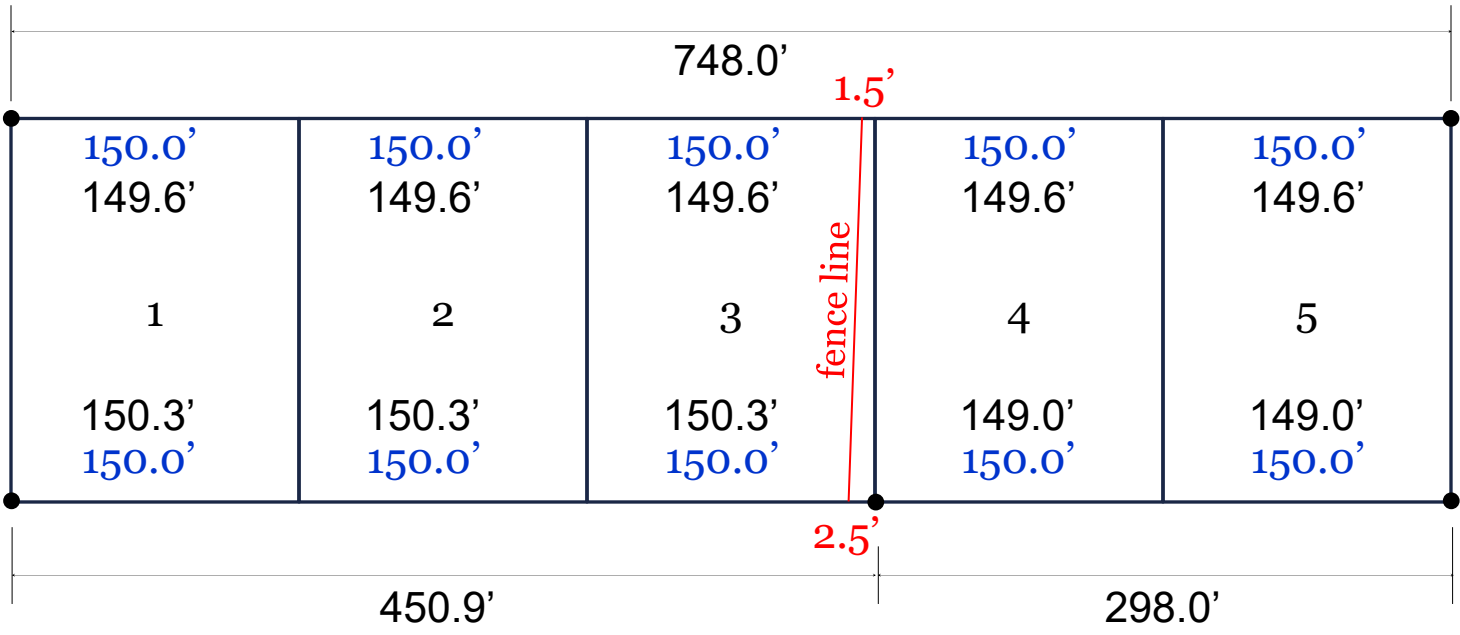

II. Unwritten Rights

Summary

Adverse Possession

is not a violation of the Statute of Frauds
is an ownership claim against a title claim
ripens when all the elements have been met
has three different time periods in Wis
affects subsequent land owners
is determined by a court



Surveyor

does not determine if land is adversely possessed
collects boundary and possession information
does not use corner est'd by adverse possession with record
information to re-est other corners



Pop Quiz!!!

1. **F** Based on his/her quasi-judicial capacity, a surveyor is able to render a boundary decision where adverse possession is involved.
2. **F** There must be intent to possess for an adverse claim to ripen.
3. **F** A court decision in a successful adverse possession case will result in new property descriptions.
4. In Wisconsin, the required time for adverse possession is: 7, 10, or 20 years .
5. **F** The same party must initiate and maintain the possession through the entire required period.
6. **F** Publicly owned land cannot be adversely possessed.
7. Possession based on a written document is called constructive possession.
8. A seemingly good deed which contains a description defect is said to have color of title.



Pop Quiz!!!

A retracement survey of White's property recovered original monuments at A and B. The line between them falls approximately 10 feet West of an existing fence built by Ms. White five years previously.

Both Mr. Green and Ms. White agreed to use the fence as their boundary line and provide parol evidence to support this.

- a. Where is the line between White and Green
- b. Is this a potential adverse possession situation?

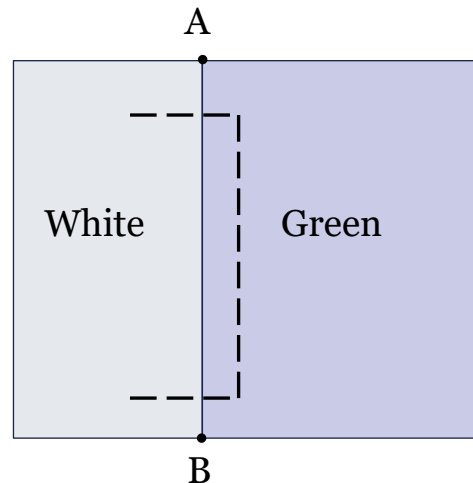

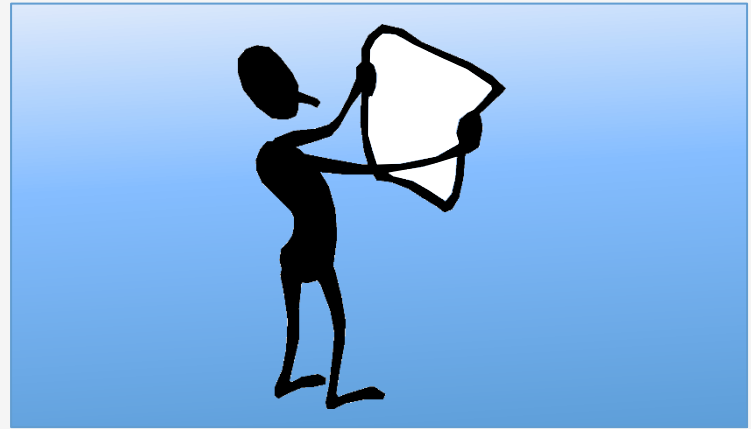

II. Unwritten Rights



- A. General
 - B. Adverse Possession
 - C. Prescription
 - D. The Surveyor and Unwritten Rights
-